

# **DOPPLER SPEED LOG**

**Doppler Speed Log**

Model: **DS-80**



- ▶ Speed and distance run indicated on a large illuminated LCD display
- ▶ Compact display unit and transducer
- ▶ High accuracy by utilizing the Doppler principle, paired beam eliminating effect of pitching, and velocity correction for change of water temperature
- ▶ Easy speed correction at mile post run

- ▶ Speed output to ARPA, radar, ECDIS, AIS, VDR, GMDSS equipment, etc.
- ▶ Complies with IMO standards MSC.96 (72), A.824 (19), A.694 (17), IEC 61023 and other related standards
- ▶ Fully meets SOLAS carriage requirement for ships over 300GT
- ▶ Fits to the hull either directly or with a gate valve

## SPECIFICATIONS

- |                     |  |
|---------------------|--|
| 1. Product Name     | DOPPLER SPEED LOG  |
| 2. Measuring System | Paired-beam Doppler log, 1 MHz   |
| 3. Display unit     | 4.5" (95 x 60 mm) Monochrome LCD<br>120 x 64 pixels  |
| Character size:     | 15 or 21 mm high selectable  |
| 4. Speed Range      | Forward: 0 - 40 kn, 0.1 kn steps<br>Astern: 0 - 10 kn, 0.1 kn steps  |
| 5. Distance Run     | 0-999,999.99 NM,<br>resettable to any value.   |
| 6. Accuracy         | Speed through-the-water (STW):<br>1%, display resolution 0.1 kn<br>Distance run: 1%, in steps of 0.1 NM<br>Deeper than 3 m |
| 7. Water Depth      |  |
| 8. Correction       |  |
| Sound velocity:     | Automatic correction for change of water temperature   |
| Mile post run:      | ±10% on menu   |
| 9. Test             | -10 and 40 kn  |
| 10. Power Supply    | 115/230 VAC  |
| 11. Interface       | IEC 61162-1  |
| Output:             | VBW, VLW   |

## ENVIRONMENT (IEC 60945 test method)

- |               |                                  |
|---------------|----------------------------------|
| Temperature   | -15°C to +55°C (Display unit)    |
| Waterproofing | Display unit; IPX5 CFR-46 (USCG) |

## EQUIPMENT LIST

- |  |        |
|--|--------|
| <b>Standard</b>                                    |        |
| 1. Main Display DS-800                             | 1 unit |
| 2. Transducer Unit DS-820<br>with 10/20/30 m cable | 1 unit |
| 3. Transceiver Unit DS-810                         | 1 unit |
| 4. Distribution Box DS-801                         | 1 unit |
| 5. Terminal Box DS-802                             | 1 unit |
| <b>Option</b>                                      |        |
| 1. Digital Indicator DS-830                        | 1 unit |
| 2. Remote Distance Indicator DS-840                | 1 unit |
| 3. Transducer Tank DS-850                          | 1 unit |
| 4. Flush Mount Kit F type or S type                | 1 unit |
| 5. Gate Valve DS-782, DS-786                       | 1 unit |
| 6. Junction Box CI-630                             | 1 unit |
| 7. Analog Display                                  | 1 unit |

## TRANSCIVER UNIT DS-810

8.0 kg, 17.6 lb

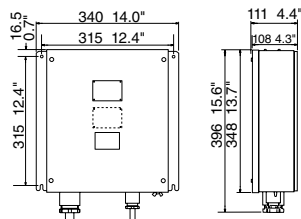

## DISTRIBUTION BOX DS-801

14 kg, 30.9 lb

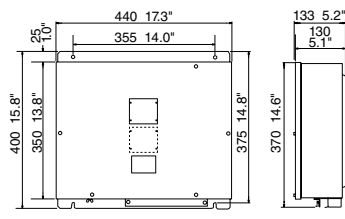

## INTERCONNECTION DIAGRAM

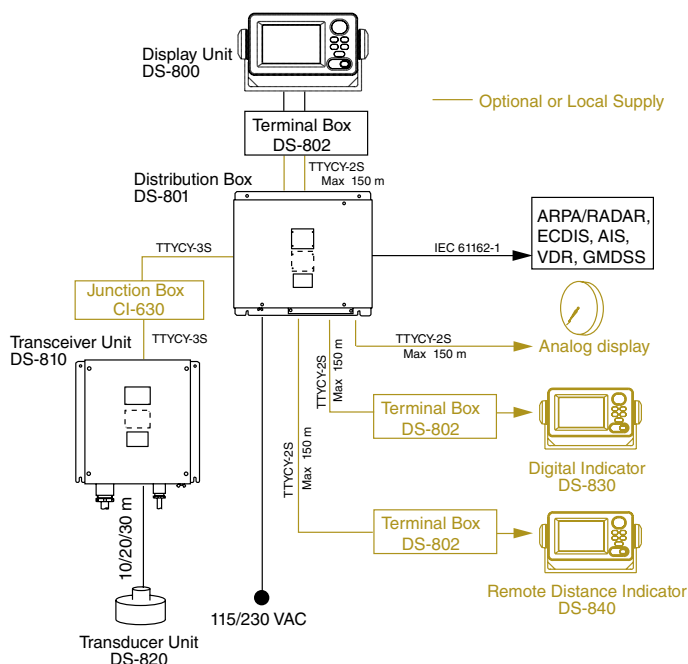

## DISPLAY UNIT DS-800

0.6 kg, 1.3 lb

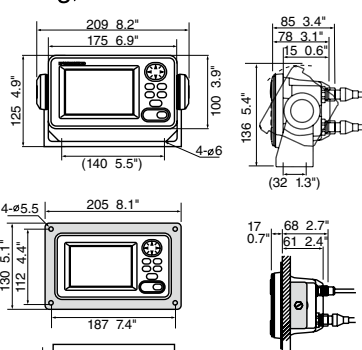

## GATE VALVE DS-782

75 kg, 165.3 lb

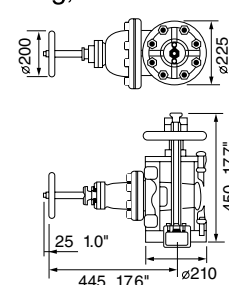

## DS-786

40 kg, 88.1 lb

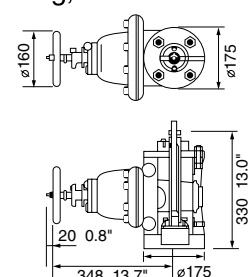

## Flush Mount Kit F type

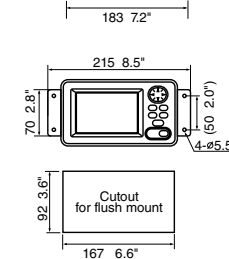

## Flush Mount Kit S type

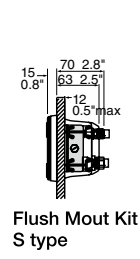

All brand and product names are registered trademarks, trademarks or service marks of their respective holders.  
SPECIFICATIONS SUBJECT TO CHANGE WITHOUT NOTICE

**FURUNO ELECTRIC CO., LTD.**  
Nishinomiya, Hyogo, Japan  
www.furuno.co.jp

**FURUNO U.S.A. INC.**  
Camas, Washington, U.S.A.  
www.furunousa.com

**FURUNO (UK) LIMITED**  
Havant, Hampshire, U.K.  
www.furuno.co.uk

**FURUNO FRANCE S.A.S.**  
Bordeaux-Mérignac, France  
www.furuno.fr

**FURUNO ESPAÑA S.A.**  
Madrid, Spain  
www.furuno.es

**FURUNO DANMARK AS**  
Hvidovre, Denmark  
www.furuno.dk

**FURUNO NORGE A/S**  
Ålesund, Norway  
www.furuno.no

**FURUNO SVERIGE AB**  
Västra Frölunda, Sweden  
www.furuno.se

**FURUNO FINLAND OY**  
Espoo, Finland  
www.furuno.fi

**FURUNO POLSKA Z o.o.**  
Gdynia, Poland  
www.furuno.pl

**FURUNO EURUS LLC**  
St. Petersburg, Russian Federation  
www.furuno.com.ru

**FURUNO DEUTSCHLAND GmbH**  
Rellingen, Germany  
www.furuno.de

**FURUNO HELLAS S.A.**  
Piraeus, Greece  
**RICO (PTE) LTD**  
Singapore  
www.rico.com.sg

10123SS Printed in Japan  
Catalogue No. FX-616F